

GUIDE TO STREAK CAMERAS

The streak camera is an ultra high-speed detector which captures light emission phenomena occurring in extremely shorttime periods.

HAMAMATSU

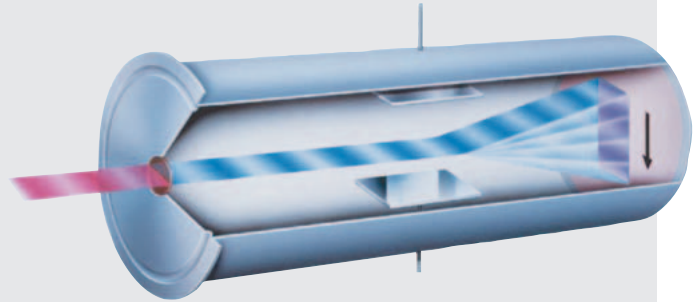
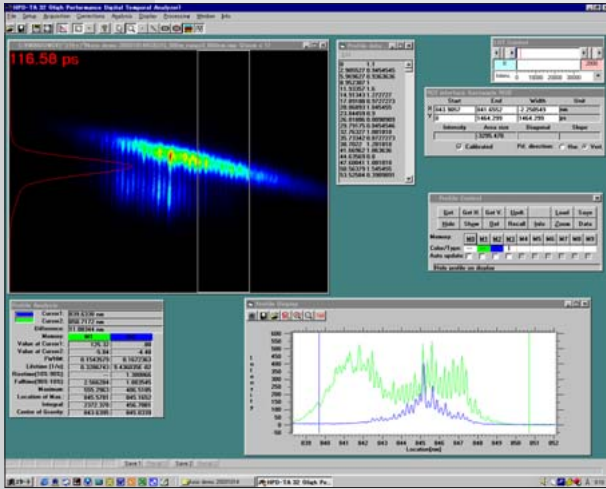

Streak Tube

Preface

This booklet has been put together in order to introduce the operating principle of streak cameras, show some examples of how streak cameras are used, offer guidelines on how to select a streak camera, and explain the terms used in connection with these instruments. We hope those who are interested in streak cameras and those who are considering buying a streak camera would find it useful. If you are looking for information on a specific product model, HAMAMATSU has individual catalogs available which describe the various models in greater detail. Please refer to those catalogs for the model in which you are interested.

Table of Contents

	Page
● What is a Streak Camera?	3
(What is a Streak Camera? / Operating Principle / Features)	
● System Configuration	4
● Definition of Terms	5
● Applications	8
(Semiconductor Physics/Photochemistry / Optical Communications / Fabrication of high quality thin films / Laser-induced Discharge / High-energy / Laser Nuclear Fusion)	
● Reference Documents Pertaining to Streak Cameras	10

What is a Streak Camera?



Although we call it a "camera", a streak camera is quite different from the video cameras and still cameras that we load with film to take pictures of the people and objects around us.

The streak camera is a device to measure ultra-fast light phenomena and delivers intensity vs. time vs. position (or wavelength) information. It's name dates back to the early days of the high speed rotating drum cameras. These cameras would "streak" reflected light onto film. No other instruments which directly detect ultra-fast light phenomena have better temporal resolution than the streak camera.

Since the streak camera is a two dimensional device, it can be used to detect several tens of different light channels simultaneously. For example, used in combination with a spectroscope, time variation of the incident light intensity with respect to wavelength can be measured (time resolved spectroscopy). Used in combination with proper optics, it is possible to measure time variation of the incident light with respect to position (time and space-resolved measurement).

Operating Principle

Fig. 1 shows the operating principle of the streak camera. The light being measured passes through a slit and is formed by the optics into a slit image on the photocathode of the streak tube. At this point, four optical pulses which vary slightly in terms of both time and space, and which have different optical intensities, are input through the slit and arrive at the photocathode.

The incident light on the photocathode is converted into a number of electrons proportional to the intensity of the light, so that these four optical pulses are converted sequentially into electrons. They then pass through a pair of accelerating electrodes, where they are accelerated and bombarded against a phosphor screen.

As the electrons produced from the four optical pulses pass between a pair of sweep electrodes, high voltage is applied to the sweep electrodes at a timing synchronized to the incident light (see Fig. 2). This initiates a high-speed sweep (the electrons are swept from top to bottom). During the high-speed sweep, the electrons, which arrive at slightly different times, are deflected in slightly different angles in the vertical direction, and enter the MCP (micro-channel plate).

As the electrons pass the MCP, they are multiplied several thousands of times, after which they impact against the phosphor screen, where they are converted again into light.

On the phosphor screen, the phosphor image corresponding to the optical pulse which was the earliest to arrive is placed in the uppermost position, with the other images being arranged in sequential order from top to bottom, in other words, the vertical direction on the phosphor screen serves as the time axis. Also, the brightness of the various phosphor images is proportional to the intensity of the respective incident optical pulses. The position in the horizontal direction of the phosphor image corresponds to the horizontal location of the incident light.

In this way, the streak camera can be used to convert changes in the temporal and spatial light intensity of the light being measured into an image showing the brightness distribution on the phosphor screen. We can thus find the optical intensity from the phosphor image, and the time and incident light position from the location of the phosphor image.

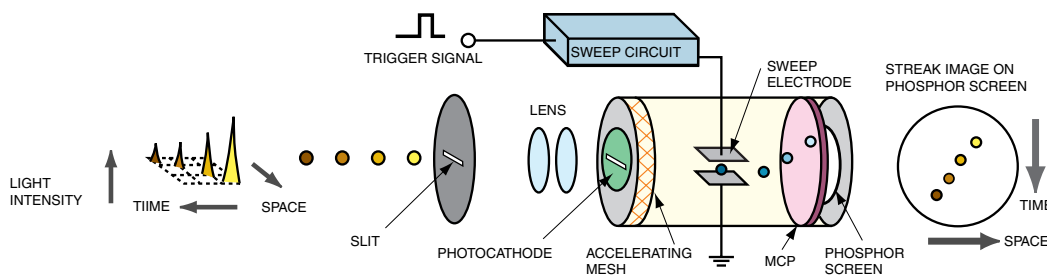

Fig.1 Operating Principle of the Streak Tube

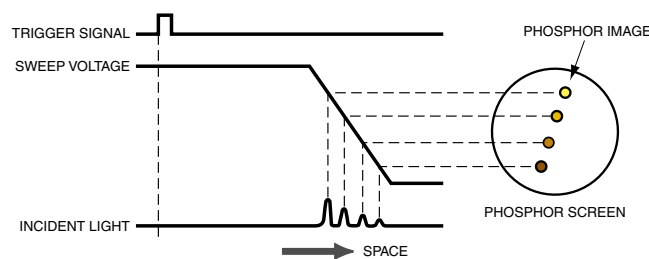

Fig.2 Operation Timing (at time of sweep)



Features

- **Simultaneous measurement of light intensity on both the temporal and spatial axis (wavelength axis)**

By positioning a multi-channel spectroscope in front of the slit (for the incident light) of the streak camera, the spatial axis is reckoned for the wavelength axis. This enables changes in the light intensity on the various wavelengths to be measured (timeresolved spectroscopy).

- **Superb temporal resolution of less than 0.2 ps**

The streak camera boasts a superb maximum temporal resolution of 0.2 ps. This value of 0.2 ps corresponds to the time it takes for light to advance a mere 0.06 mm.

- **Handles anything from single event phenomena to high-repetition phenomena in the GHz range**

A wide range of phenomena can be measured simply by replacing the modular sweep unit.

- **Measurement ranges from X-rays to the near infrared rays**

A streak tube (detector) can be selected to match any wavelength range from X-rays to near infrared rays.

- **Ultra-high sensitivity (single photoelectron can be detected)**

The streak tube converts light into electrons, and then multiply it electrically. By this, it can measure faint light phenomena not to be seen by the human eyes. This enables monitoring of extremely faint light, even single photoelectron can be detected.

- **Dedicated readout system**

A dedicated readout system is available which allows images recorded by a streak camera (streak images) to be displayed on video monitor and analyzed in real time. This enables the data to be analyzed immediately without the delay of film processing.

System Configuration



In order to measure ultra-high speed optical phenomena using a streak camera, a trigger section and a readout section are required. The basic configuration of this system is shown below.

The trigger section controls the timing of the streak sweep. This section has to be adjusted so that a streak sweep is initiated when the light being measured arrives at the streak camera. For this purpose, we use a delay unit, which controls how long the trigger signal which initiates the streak sweep is delayed, and a frequency divider, which divides the frequency of the external trigger signal if the repetition frequency of the trigger signal is too high. Also, in cases where the trigger signal cannot be produced from the devices such as a laser, it has to be produced from the light being measured itself, and this requires a PIN photodiode.

The readout section reads and analyzes streak images produced on the phosphor screen, which is on the output side of the streak camera. Because the streak image is faint and disappears in an instant, a high-sensitivity camera is used. Analysis of streak images is done by transferring the images through a frame grabber board to a computer.

In addition to the units which make up this basic configuration, there are spectroscopes, optics, and other peripheral equipments which can be used depending on each applications

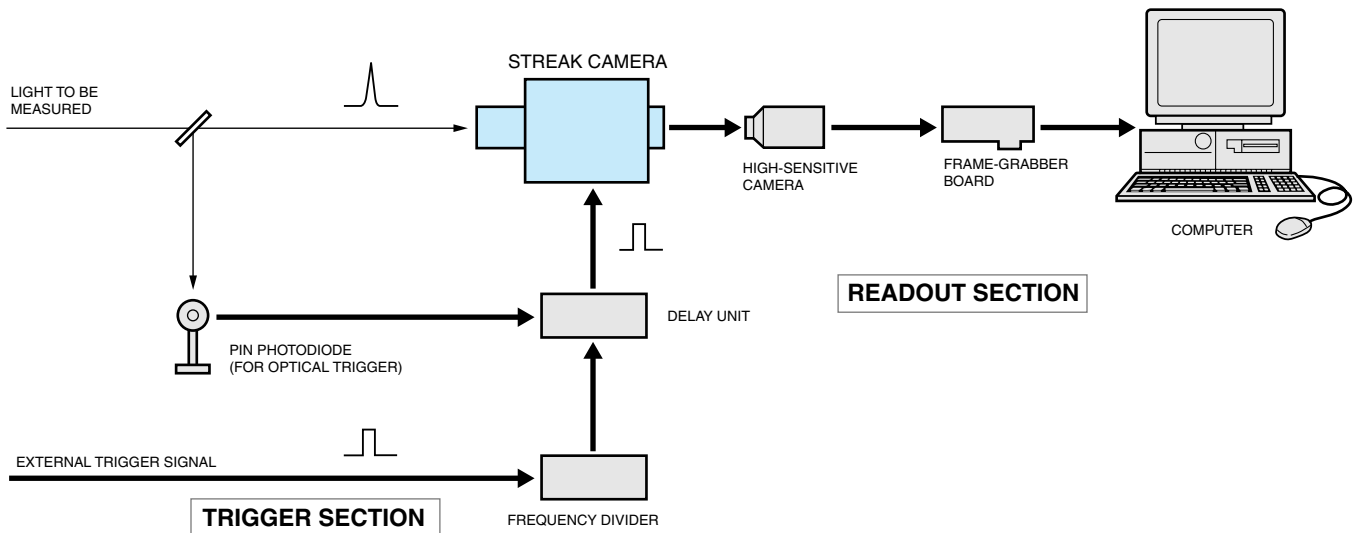

Fig.3 Basic System Configuration of Streak Camera

Definitions of Terms

Time Characteristic / Unit / Gate / Trigger

• Temporal Resolution

This is the boundary of the resolution which distinguishes between two events which are consecutive in terms of time. In HAMAMATSU catalogs, the temporal resolution is defined as the FWHM (full width at half maximum) of the intensity of the streak image in relation to an incident light pulse whose temporal width (pulse width) can be infinitely close to but not equal to zero.

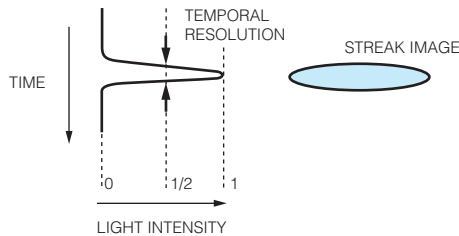

Fig. 4 Temporal Resolution

• Picosecond (ps) / Femtosecond (fs)

One picosecond is equal to one-trillionth of a second (10^{-12} second). Light in vacuum travels 0.3 mm in a picosecond. One femtosecond is equal to 1/1000 th of a picosecond (1/one thousand trillionth of a second, or 10^{-15} second).

• Gate

This is an operation carried out in order to render the streak camera temporarily insensitive.

If light positioned before and after the light in the field being measured is allowed to enter the streak camera, the photoelectrons produced by that light will be scattered and multiplied inside the streak tube, causing optical noise to appear on top of the actual streak image, and lowering the S/N of the streak image. In order to prevent this problem, the streak camera is equipped with a cathode gate which blocks the photoelectrons produced on the photocathode and an MCP gate which stops electrons from being multiplied in the MCP.

• Gate Extinction Rate

This is the ratio of the phosphor screen brightness when the gate is open and when it is closed, in relation to incident light which is constant in terms of time.

• Dynamic Range

This indicates the light intensity range which can be measured with the streak camera. In this booklet and HAMAMATSU catalogs, the dynamic range is specified as the weakest pulse which can actually be measured, instead of the noise level, which has conventionally been used to define the dynamic range. In other words, the ratio between the strongest pulse and the weakest pulse in the range of the input/output linearity ($\gamma = 1$) is taken as the dynamic range. Generally speaking, there is a tendency for the dynamic range to become lower as the temporal resolution improves.

• Trigger Delay

In order to obtain a streak image in the center of the phosphor screen, the trigger signal has to arrive at the slit earlier than the incident light. The trigger delay is used to achieve this difference in timing.

• Trigger Jitter

When a phenomenon is being repeated in order to measure it (streak images are being summed), the position of the streak image on the phosphor screen jumps slightly each time the phenomenon is repeated, because of fluctuation in the operation timing of the sweep circuit and other factors. This fluctuation is called trigger jitter, and is one element which limits the temporal resolution of the system. It can be a particular problem with high-speed sweeps. (With low speed sweeps, the trigger jitter is lower than the time resolution, and can be ignored.)

The trigger jitter is determined by the difference between the FWHM of a single pulse and the FWHM when pulses are summed together.

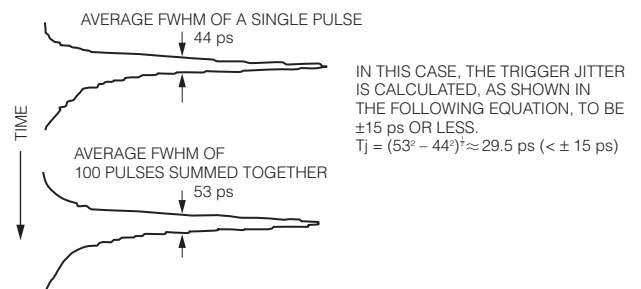

Fig. 5 Determining Trigger Jitter

Sweep Method / Measurement Method

• Single-Sweep

Essentially, this term comes from the fact that only one sweep is involved (a single shot). In this booklet and in HAMAMATSU catalogs, however, we use the term to refer to any sweep ranging from a single shot to sweeps with a repetition rate of up to tens of kHz. The measurement range which covers this sweep method is from 60 ps to 10 ms. A ramp voltage is applied to the deflection (sweep) electrodes during the sweep. (see Fig. 6)

• Synchroscan

This refers to a high-speed repeated sweep in which a high-frequency sinuswave voltage is applied to the deflection electrodes (see Fig. 6). By synchronizing the repeated sweep frequencies, streak images can be accumulated (integrated) at a fixed position on the phosphor screen. This allows very faint optical phenomena to be measured with a high S/N.

The repetition of the optical phenomenon is the same as the sweep

frequency, but it must be an integral multiple or an integral fraction of the sweep frequency. The temporal measurement range is from several hundred ps to 2 ns or 3 ns.

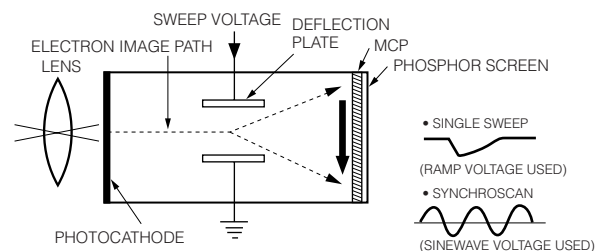

Fig. 6 Sweep Voltages for Single-sweep and Synchroscan

• Synchronous Blanking

With the synchroscan method, because only vertical deflection plates are used and repeated sweeps carried out in the vertical direction, if there is incident light during the return sweep (the sweep from the bottom back to the top), this will overlap the signal of the main sweep (the sweep from the top to the bottom) as a spurious-signal. This makes it very difficult to obtain accurate measurements.

In synchronous blanking, a sinewave with a phase different from that of the vertical sweep signal is applied to the horizontal deflection plates, and the return sweep is forced off its course in the horizontal direction. As shown in Fig. 10, the return sweep thus misses the phosphor screen, allowing only the main sweep to be measured, and this enables accurate measurement of high-speed repeated phenomena up to the GHz range.

Comparison of Methods of Observing a 1.5 μm Semiconductor Laser (modulated at 2 GHz)

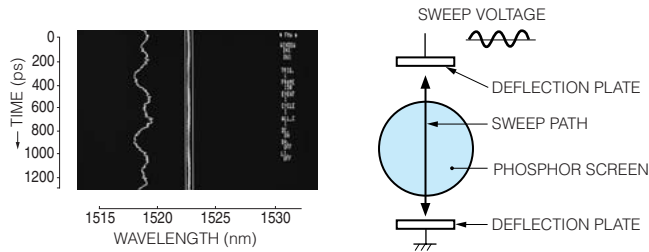

The image resulting from incident light during the return sweep overlaps with the signal from the main sweep.

Fig.7 Sweep Path Using Synchroscan

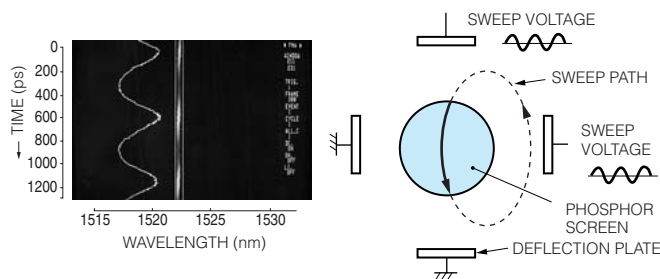

The use of elliptical sweep so that the return sweep does not pass over the phosphor screen enables measurement of only the signal from the main sweep. (The photo was obtained using the data analyzer to perform vertical compensation for streak image bending.)

Fig.8 Sweep Path Using Synchronous Blanking

• Dual Time Base

In addition to the synchroscan, by applying a ramp voltage to the horizontal deflection plates, the repeated vertical sweep shifts in the horizontal direction (horizontal sweep). This allows temporal information to be captured in the horizontal direction as well as the vertical direction. The vertical axis represents the fast time axis, while the horizontal axis shows the slow time axis. By having two time axis, it is possible, for example, to measure pulse widths and phase fluctuations which are sufficiently longer than the repetition frequency of events which repeat at highspeed.

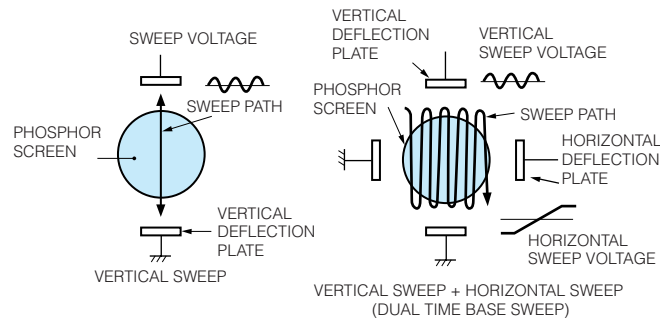
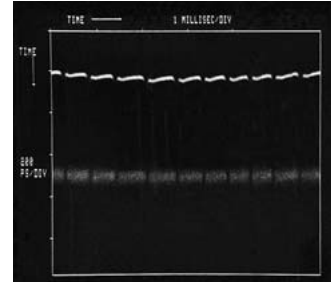

Fig. 9 Sweep Path Using Dual Time Base



Jitter measurement example of a mode-locked YAG laser and a sync pump dye laser excited by the YAG laser's second harmonic (top: dye laser, bottom: YAG second harmonic)

• Photon Counting Integration

Photoelectrons taken off from the photocathode of the streak tube are multiplied at a high integration rate by the MCP, and one photoelectron is counted as one intensity point on the phosphor screen. A threshold value is then used with this photoelectron image to clearly separate out noise.

Positions in the photoelectron image which are above the threshold value are detected and are integrated in the memory, enabling noise to be eliminated completely. This makes it possible to achieve data measurements with a wide dynamic range and high S/N.

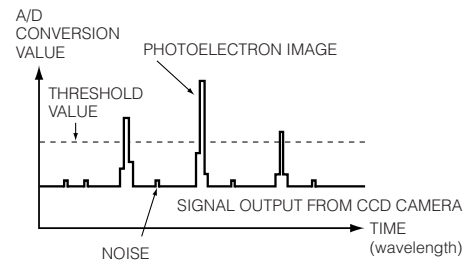

Fig. 10 Separation of Photoelectron Image and Noise

• Time-resolved Spectroscopy

In time-resolved spectroscopy, temporal fluctuation in the intensity of light at various wavelengths are measured. A spectroscope is set in front of the streak camera, and light separated in the horizontal direction is collected and an image formed at the level input slit in order to be measured. (See Application Examples 1, 2, and 3 on page 8.)

• Time and space-resolved Measurement

This is a type of measurement in which temporal fluctuation in the intensity of the light are measured at the position of the light being measured. This is done by using a lens system appropriate to optical images in the target range and forming an image on the input slit surface of the streak camera. (See Application Examples 4, 5, and 6 on page 9.)

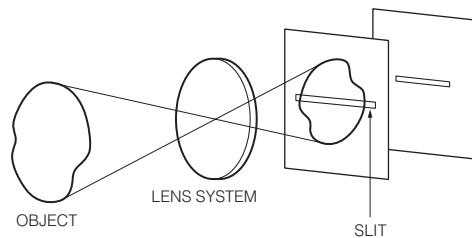

Fig. 11 Time and space-resolved Measurement



Input / Output / Readout System / Optical

• Input Optics

This is an optics which is positioned in front of the photocathode of the streak tube. Its function is to make the light being measured into fine slit ray and make it focused on the photocathode. It consists of a slit section and a lens section. Various models are available, classified by the spectral transmittance and brightness of the lens system.

• Output Optics

This is an optics which is positioned between the phosphor screen on the output side of the streak tube and the camera used for readout. It is used to form an image on the sensitive surface of the camera which reads the streak image formed on the phosphor screen.

• Photocathode

This is configured of numerous layers of various types of metallic film, layered on the surface of the window material, so that when light strikes this surface, the light energy is absorbed and electrons called photoelectrons are emitted. The wavelength range of the incident light from which these photoelectrons are generated, and the conversion efficiency, differ depending on the material making up the photocathode.

• Spectral Response Characteristics

The percentage of photoelectrons emitted from the photocathode to the number input in the incident light varies depending on the wavelength of the light. This is called the spectral response characteristic and, depending on how definitions are used, it is expressed in terms of quantum efficiency and radiant sensitivity.

• Radiant Sensitivity

This indicates how many amperes (A) of photoelectric current are produced when 1 watt (W) of incident light is entered in the photocathode. It is expressed as the proportion of the incident light to the photoelectric current (A/W).

• Quantum Efficiency

This is the ratio between the number of incident photons on the photocathode and the number of photoelectrons generated. It is calculated using the following equation: No. of photoelectrons/ no. of incident photons $\times 100$ (%).

• Phosphor screen

This is a screen which produces light when electrons bump against it. This is where the electron image is optically converted into a streak image. The phosphor screen consists of a glass plate and layers of fluorescent material on the surface of the plate. The amount of light generated by the fluorescent material is proportional to the kinetic energy of the electrons. The peak and attenuation time of the spectrum vary depending on the type of phosphor screen used. Phosphor screens are classified by P numbers, such as P-11, P-20 or P-43.

• MCP

This is an abbreviation for Micro Channel Plate. The MCP is an electron multiplier consisting of many thin glass capillaries (channels) with internal diameters ranging from 10 μm to 20 μm , bundled together to form a disk-shaped plate with a thickness of 0.5 mm to 1 mm. The internal walls of each individual channel are coated with a secondary electron emitting material, so that as the electrons come flying through the channels, they bump against the walls, and the repeated impact causes them to multiply in number. A single electron can be multiplied into as many as 10^4 using this process.

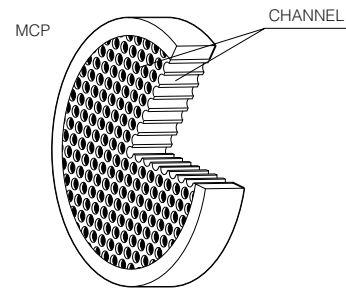

Fig. 12 MCP Configuration

• Material of Windows

This is a substrate formed by either the photocathode or the phosphor screen, and is made of material with a superb light transmission characteristic. Various materials such as MgF_2 , UV transmitting glass, and fiber plate are used as window materials. The window material varies depending on the boundary transmittance wavelength of the UV region.

• CCD Camera

CCD cameras are the preferred devices for reading the images from the phosphor screens of streak cameras. Hamamatsu is offering various camera types; including cooled or non-cooled, digital or analog, slow-scan or fast-scan lens-coupled or fiberoptically coupled. So, the ideal CCD camera can be selected for a given streak camera model and application.

• Streak Trigger Unit (Frequency Divider)

This divides signals which have a repetition frequency too high to be handled by a single sweep unit, and supplies gate trigger signals and streak trigger signals to the single sweep unit.

• Delay Unit

This unit can be used to specify the delay time in steps as short as 30 ps.

• PIN Photodiode

It is a device to convert the incident light pulse into the streak trigger signal for single sweep unit or synchroscan unit. For single sweep unit, a slow repetition pulse laser is used as the applicable light source. For synchroscan unit, a mode-locked laser is used as the applicable light source.

Applications

1 Semiconductor Physics (photoluminescence of GaAlAs)

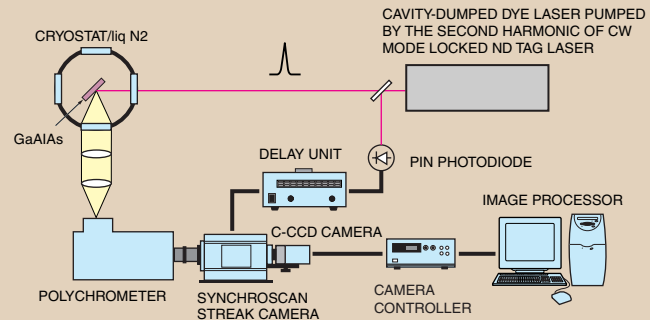
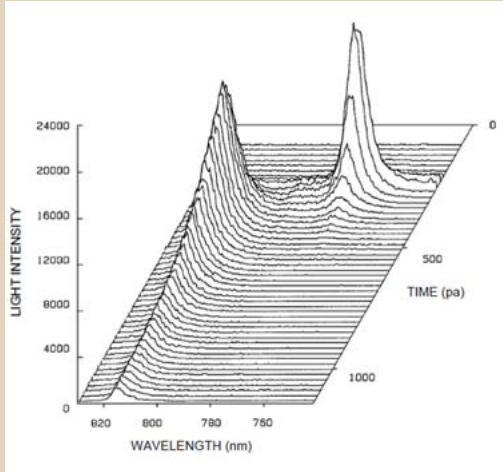

This is an example showing the photoluminescence of the compound semiconductor GaAlAs undergoing time-resolved spectroscopy. The specimen (GaAlAs) was excited using 580 nm picosecond pulses, and the photoluminescence emitted when electrons return to the ground state pass through a spectroscope where they undergo wavelength analysis. Following this, temporal resolution is carried out using a streak camera.

2 Photochemistry (Picosecond time-resolved absorption of photochromic compound)

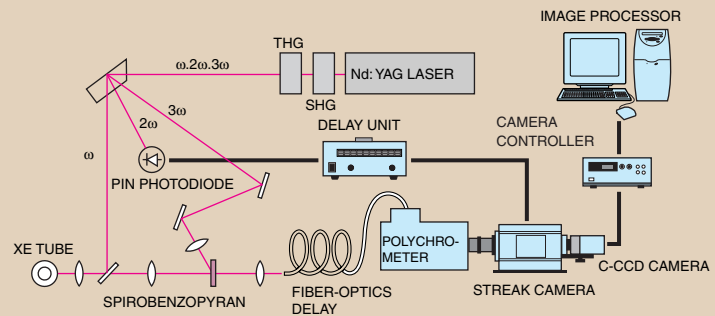
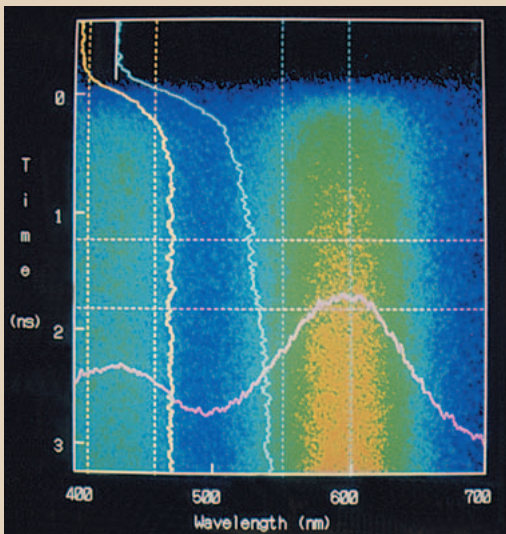

The absorbance change of Spirobenzopyran in polystyrene film are measured by streak camera after the 355 nm excitation. The vertical curve shows the temporal changes in the degree of absorption in the first half of the 400 nm band and in the second half of the 500 nm band. The horizontal curve shows the absorption spectrum around 1.5 ns after excitation.

3 Optical communication (Chromatic dispersion in single mode optical fiber)

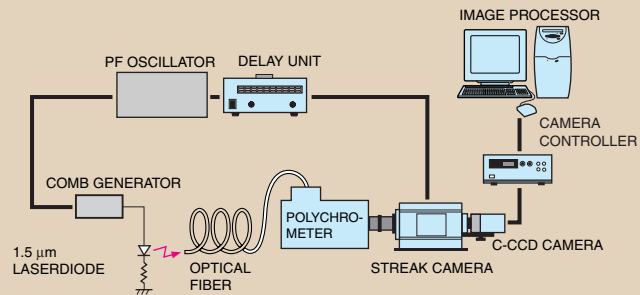
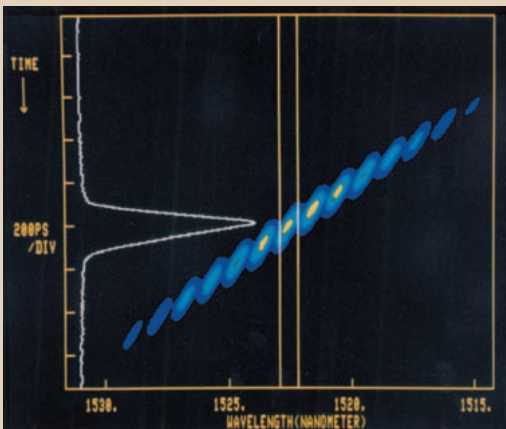

This is an example of a measurement of dispersion in time occurring in optical fiber. A laser diode with a wavelength of 1.5 μm generates many pulses having different wavelength at same timing, which are input to the optical fiber to be measured. The speed of the each optical pulses transmitting through the optical fiber varies depending on its wavelength. Thus, when the output light undergoes time-resolved spectroscopy after being transmitted a long distance, the differences of arrival time depending on each wavelength of a pulse can be measured.



4 Fabrication of high quality thin films (Laser ablation of YBCO)

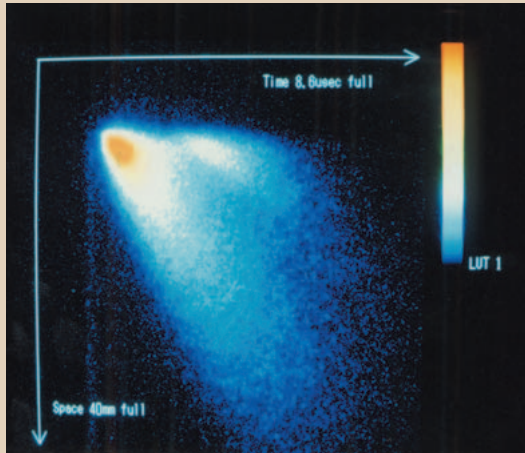

▲ Photo courtesy of Superconductivity Reserch Laboratory, ISTEK

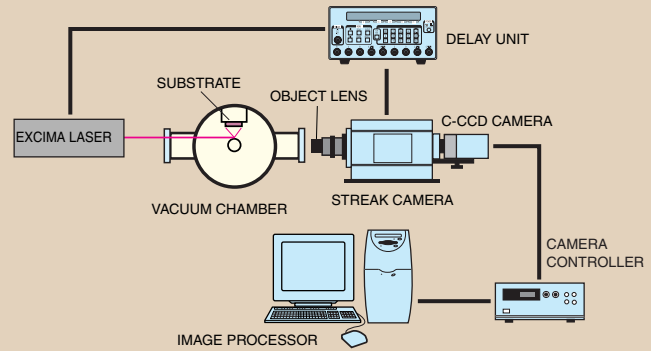

This example shows how, in order to create an oxide superconductivity thin film, the particles generated by a laser shot to a target scatter onto a substrate. We can see from the results that there are two components involved: one which arrives at the substrate at high speed, and a slower component which takes longer to reach the substrate.

5 Laser induced discharge

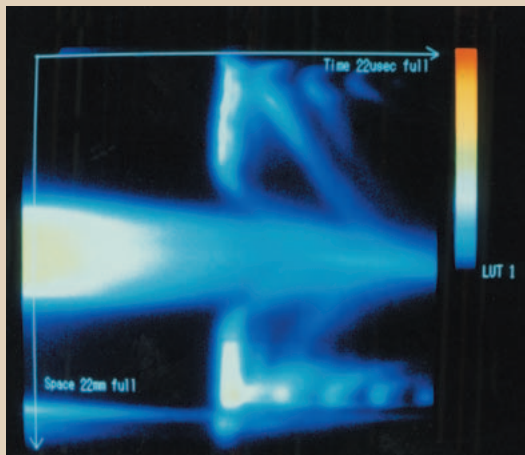

▲ Photo courtesy of Assistant Prof. Honda Graduate School of Engineering Sciences, Kyushu University

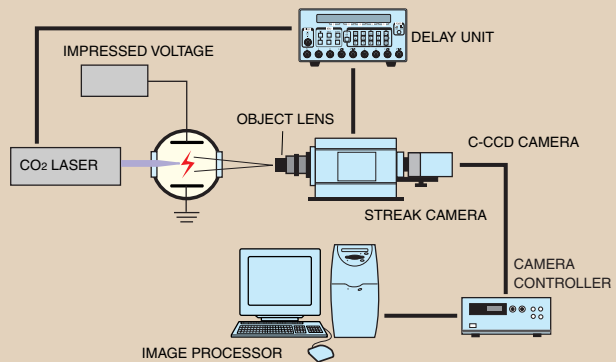

In this example, laser-induced discharge is measured. By focusing a strong pulsed beam between electrodes to which a direct-current high voltage has been applied, plasma is created, and this induces electrical discharge between the electrodes.

6 High energy Laser nuclear fusion

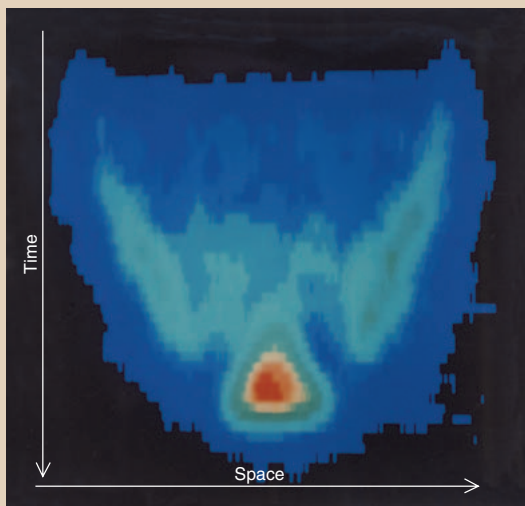

▲ Photo courtesy of Institute of Laser Engineering, Osaka University

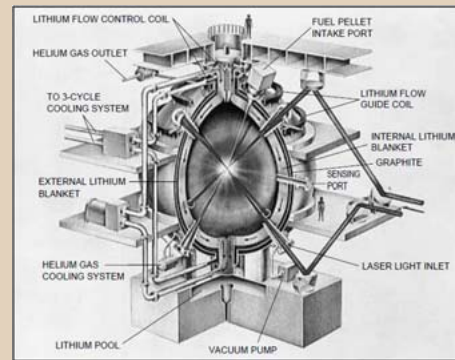

▲ Laser nuclear fusion reactor (photo courtesy of Institute of Laser Engineering, Osaka University)

When a light element initiates nuclear fusion and changes to a heavy element, explosive energy is given off which is nothing like the chemical energy seen in combustion and other forms. Measurement of the intensity and the response time of light produced through the explosive flux-compression which takes place in the nuclear fusion reactor takes place here, along with measurement of the density and distribution of plasma ions and other factors.

Reference Documents Pertaining to Streak Cameras

Condensed matter of semiconductor

- **Cooling of hot carriers in Ga_{0.47}In_{0.53}As**
H. Lobentanzer, H. J. Polland, W. W. Rühle, W. Stolz and K. Ploog Appl. Phys. Lett. 51 (9) 673 (1987)
- **Tunneling escape time of electrons from a quantum well under the influence of an electric field**
T. B. Norris, X.J. Song, W. J. Schaff, L. F. Eastman, G. Wicks, G. A. Mourou Appl. Phys. Lett. Vol. 54, pp. 60-62, 1989 (Continued)
- **Time-of flight measurement of excitonic polaritons in a GaAs / AlGaAs quantum well**
K. Ogawa, T. Katsuyama, H. Nakamura Appl. Phys. Lett. Vol. 53, pp. 1077-1079, 1988
- **Fast beam switching in surface-emitting distributed Bragg reflector**
Keisuke Kojima, Kazuo Kyuma Appl. Phys. Lett. Vol. 53, pp. 1357-1359, 1988
- **Time resolved luminescence study of recombination processes in electroluminescent polymers**
U. Lemmer, R.F. Mahrt, Y. Wada et al. Appl. Phys. Lett. 62 (22), 1993
- **A picosecond spectroscope with a high wavelength resolution, designed for measurement of physical properties.**
T. Itoh and S. Suto
Kotai Butsuri Vol. 22, pp. 795-803, 1987
(Written in Japanese)
- **Measurement of Weak Luminescence from Semiconductors Using the Synchroscan Streak Camera System**
J. Kusano, Y. Segawa and S. Namba
The Review of Laser Engineering Vol. 14, No. 8 pp. 701-705, 1986
(Written in Japanese)
- **Femtosecond • Picosecond Emission Spectroscopy**
H. Utsugi and T. Kobayashi
Butsuri Vol. 42, pp. 486-492, 1987
(Written in Japanese)

Photochemistry

- **Picosecond time-resolved absorption spectrometer using a streak camera**
T. Ito, M. Hiramatsu, M. Hosoda and Y. Tsuchiya Rev. of Sci. Inst., Vol. 62, No. 6, pp. 1415-1419, 1991
- **Absence of dielectric relaxation effects on intramolecular electron transfer in porphyrin-quinone cyclophanes**
F. Pöllinger, H. Heitele, M. E. Michel-Beyerle, et al CHEMICAL PHYSICS LETTERS, Vol. 198, No. 6, pp.645-652, 1992
- **Use of streak camera for time-resolved photon counting fluorimetry**
Lloyd M Davis and Christian Parigger Meas. Sci. Technol. 3, pp. 85-90, 1992
- **Picosecond Time-resolved Multiplex CARS Spectroscopy by using a streak camera: Isomerization Dynamics of All-trans and 9-cis Retinal in the Lowest Excited Triplet St**
T. Tahara, B. N. Toleutaev and H. Hamaguchi to be published in J. Chem. Phys.
- **Picosecond Raman spectroscopy using a streak camera**
Tahei Tahara and Hiro-o Hamaguchi
Appl. Spectrosc., 47, 391 (1993)

Biology / Medical Science

- **Estimation of optical pathlength through tissue from direct time of flight measurement**
D T Delpy, M Cope, P van der Zee et al
Phys. Med. Bid., Vol. 33, No. 12, pp. 1433-1442, 1988
- **Development of a Streak-Camera-Based Time-Resolved Microscope Fluorimeter and Its Application to Studies of Membrane Fusion in Single Cells**
Akihiro Kusumi, Akihiko Tsuji, Masayuki Murata et al
Biochemistry, Vol. 30, No. 26, pp. 6517-6527, 1991
- **Line scan acquisition for time-resolved imaging through scattering media**
Jeremy C. Hedden
Optical Engineering, Vol. 32, No. 3, pp. 626-633, 1993
- **Picosecond Time-Resolved Emission Spectroscopy Using a Single-Photon Sensitive Synchroscan Streak Camera**
M. Yamashita, S. Kobayashi and M. Ishikawa
Journal of the Spectroscopical Society of Japan Vol. 34 No. 3, 1985
(Written in Japanese)



Plasmas / Electric discharge / Combustion

- **Time-resolved visible spectroscopy of laser-produced lithium plasmas**

J. Bailey, G. C. Tisone, M. J. Hurst, et al
Rev. Sci. Instrum., 59 (8), pp. 1485-1487, 1988

- **Measurements of lateral thermal smoothing of 0.53 μm laser intensity nonuniformities via shock-wave analysis**

C. L. Shepard, P. M. Campbell
PHYSICAL REVIEW A, Vol. 39, No. 3, pp. 1344-1350, 1989

- **Dynamics of laser-ablated particles from high Tc superconductor $\text{YBa}_2\text{Cu}_3\text{O}_y$**

O. Eryu, K. Murakami and K. Masuda
Appl. Phys. Lett. 54 (26), pp. 2716-2718, 1989

- **Spectroscopic Analysis of Diesel Combustion Flame by Means of Streak Camera**

K. Nagase, K. Funatsu and I. Haga
Lecture Theses of the 7 th International Combustion Engine Symposium, Japan., No. 123, 1988
(Written in Japanese)

Research of Lasers

- **Pulse shortening of actively mode-locked diode lasers by wavelength tuning**

M. Serenyi, and J. Kuhl, E. O. Gobel
Appl. Phys. Lett. 50 (18), 12, 13 (1987)

- **InGaAsP monolithic extended-cavity lasers with integrated saturable absorbers for active, passive, and hybrid mode locking at 8.6 GHz**

P. B. Hansen, G. Raybon, U. Koren et al
Appl. Phys. Lett. 62 (13), pp. 1445-1447, 1993

- **Applications of synchroscan and dual-sweep streak camera techniques to free-electron laser experiments**

Alex H. Lumpkin
SPIE Vol. 1552 short-wavelength Radiation Sources (1991)

- **Optical diagnostics for a ring resonator free-electron laser**

M. L. Laucks, A. R. Lourey, D. H. Dowell et al
Optical Engineering, Vol. 32, No. 2, pp. 384-394, 1993

Optical Communications

- **Direct measurement of chromatic dispersion in singlemode fibres using streak camera**

K. Mochizuki, M. Fujise, H. Suzuki, M. Watanabe, M. Koishi and Y. Tsuchiya

- **100 Gbit/s optical signal generation by time-division multiplication of modulated and compressed pulses from gain-switched distributed feedback (DFB) laser diode**

A. Takada, M. Saruwatari
Electron. Lett. 24, pp. 1406-1408, 1988

- **Amplification of high repetition rate picosecond pulses using an InGaAsP traveling-wave optical amplifier**

G. Eisenstein, P. B. Hansen, J. M. Wiesenfeld, R. S. Tucker, G. Raybon
Appl. Phys. Lett. Vol. 53, pp. 1539-1541, 1988

- **64Gb/s All-Optical Demultiplexing with the Nonlinear Optical-Loop Mirror**

P. A. Andrekson, N. A. Olsson, J. R. Simpson et al
IEEE PHOT. TEC. LETTERS, Vol. 4, No. 6, 1992

- **Laser-diode driven ultrafast all-optical switching by using highly nonlinear chalcogenide glass fiber**

Masaki Asobe, Hideki Kobayashi, Hiroki Itoh and Terutoshi Kanamori
OPTICS LETTERS, Vol. 18, No. 13, 1993
Appl. Phys. Lett. Vol. 53, pp. 1539-1541, 1988

Electron Beam

- **Transverse and longitudinal beam profile measurement using optical techniques in TRISTAN accumulation ring**

A. Ogata, T. Ieiri, K. Nakajima and Y. Mizumachi
IEEE Transactions on Nuc. Sci. Vol. NS-32, pp. 1944-194, 1985

- **Time Structure Monitoring of the Electron Beam in a Linear Accelerator**

S. Owaki
Jpn. J. of Appl. Phys. 22, pp. 723-727, 1983

- **Measurement of bunch lengthening in TERAS**

S. Sugiyama, T. Yamazaki, T. Noguchi, et al
Rev. Sci. Instrum. 60 (7), pp. 1748-1751, 1989

- ★ **Product and software package names noted in this documentation are trademarks or registered trademarks of their respective manufacturers.**
- Subject to local technical requirements and regulations, availability of products included in this promotional material may vary. Please consult your local sales representative.
 - Information furnished by HAMAMATSU is believed to be reliable. However, no responsibility is assumed for possible inaccuracies or omissions.
- Specifications and external appearance are subject to change without notice.
- © 2008 Hamamatsu Photonics K.K.

HAMAMATSU

Homepage Address www.hamamatsu.com

HAMAMATSU PHOTONICS K.K., Systems Division

812 Joko-cho, Higashi-ku, Hamamatsu City, 431-3196, Japan, Telephone: (81)53-431-0124, Fax: (81)53-435-1574, E-mail: export@sys.hpk.co.jp

U.S.A. and Canada: Hamamatsu Corporation: 360 Foothill Road, Bridgewater, N.J. 08807-0910, U.S.A., Telephone: (1) 908-231-0960, Fax: (1) 908-231-0852, E-mail: usa@hamamatsu.com

Germany: Hamamatsu Photonics Deutschland GmbH: Arzbergerstr. 10, D-82211 Herrsching am Ammersee, Germany, Telephone: (49)8152-375-0, Fax: (49)8152-2658, E-mail: info@hamamatsu.de

France: Hamamatsu Photonics France S.A.R.L.: 19, Rue du Saule Trapu, Parc du Moulin de Massy, 91882 Massy Cedex, France, Telephone: (33)1 69 53 71 00, Fax: (33)1 69 53 71 10, E-mail: infos@hamamatsu.fr

United Kingdom: Hamamatsu Photonics UK Limited: 2 Howard Court, 10 Tewin Road, Welwyn Garden City, Hertfordshire, AL7 1BW, U.K., Telephone: (44) 1707-294888, Fax: (44) 1707-325777, E-mail: info@hamamatsu.co.uk

North Europe: Hamamatsu Photonics Norden AB: Smidesvägen 12, SE-171-41 Solna, Sweden, Telephone: (46)8-509-031-00, Fax: (46)8-509-031-01, E-mail: info@hamamatsu.se

Italy: Hamamatsu Photonics Italia S.R.L.: Strada della Moia, 1 int.6-20020 Arese (Milano), Italy, Telephone: (39)02-935 81 733, Fax: (39)02-935 81 741, E-mail: info@hamamatsu.it

Cat. No. SHSS0006E01
APR/2008 (2008.2) IP
Printed in Japan